



Wyznaczamy nowy poziom jakości

Od ponad trzydziestu lat stale rozwijamy się dla Ciebie, łącząc nowoczesny design z perfekcyjnym wykonaniem. Dzięki najnowszym technologiom obróbki i wytwarzania powstają wyjątkowe uchwyty dostosowane do potrzeb Twojego wnętrza.



We set new quality standards

We have been developing continuously for you for more than thirty years now combining modern design with perfect workmanship. Thanks to the most modern technologies of manufacturing and processing we produce handles which can best match the needs of your interior.



Wir setzen Maßstäbe

Seit 30 Jahren entwickeln wir uns ständig weiter, indem wir das moderne Design mit perfekter Ausführung verbinden. Dank der neuesten Bearbeitungs- und Herstellungstechnologien entstehen ungewöhnliche Möbelgriffe, die Ihren individuellen Bedürfnissen sowie räumlichen Gegebenheiten angepasst sind.



Мы устанавливаем новый уровень качества

Более тридцати лет мы непрерывно развиваемся для Вас, сочетая современный дизайн с совершенным исполнением. Благодаря новейшей технологии обработки и изготовления создаем уникальные ручки учитывающие потребности вашего интерьера.

premium



aluminium



vintage



classic



modern



standard



KATALOG UCHWYTÓW 2016

Oznaczenia w tabelach

symbols in the tables / Merkmale in Tabellen / Маркировка в таблицах

Letto		Nazwa			
G2, G5, G6, G8		name / Bezeichnung / Название			
S	W	H	L		
P					
C-5065	160	11	34	203	25
C-5069-320	320	11	34	363	25

rodzaj pokrycia
type of coating / Beschichtungsart
Покрытие
S - rozstaw otworów (mm) hole spacing / Bohrabstand Расстояние между отверстиями
Ø - średnica (mm) diameter / Durchmesser / Диаметр
W - szerokość (mm) width / Breite / Ширина
H - wysokość (mm) height / Höhe / Высота
L - długość (mm) length / Länge / длина
P - pakowanie ilość (szt.) number of pieces packed Verpackung (Stck.) / Фасовка (шт.)

A - gałka
knob / Möbelknopf / кнопка
C - uchwyt
handle / Möbelgriff / ручка
Z - wieszak
hook / Möbelhaken / крючок

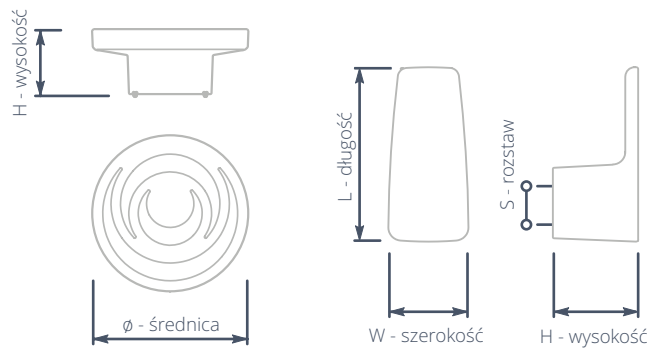
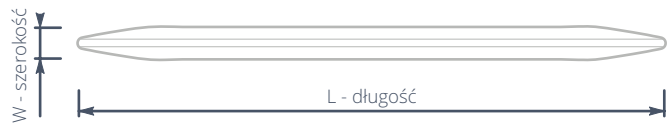

premium 03 - 18



aluminium 19 - 26



vintage 27 - 33



classic 34 - 40

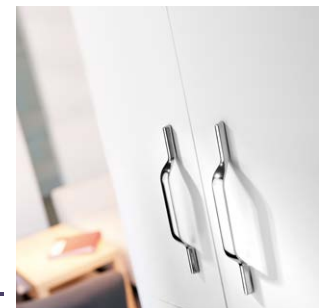

Rodzaj pokrycia

type of coating / Beschichtungsart / тип покрытия

A - powłoka anodowana / anodized finish / eloxierte Beschichtung / анодированный алюминий
G - powłoka galwaniczna / galvanic finish / Oberfläche galvanisiert / гальваническое покрытие
TL - powłoka lakierowana / lacquered finish / Lack / лак
P - lakiery proszkowe / powder coating / Pulverlack / порошковая краска

G2 chrom polysk glossy chrome chrom glanz хром блестящий	G4 patyna na miedzianym antique brass altmessing старая латунь	G5 nikiel mat nickel matt никель матовый	G6 chrom mat chrome matt хром матовый
G8 efekt stali szlachetnej brushed steel effect edelstahleffekt эффект благородной стали	G35 srebro postarzone old silver altsilber старое серебро	G49 oyna postarzana old tin effect altzinn старое олово	TL20 efekt miedzi copper effect Kupferfarbe эффект меди
P1 biały white weiß белый	P2 czarny black schwarz черный	P59 czarna połysk glossy black schwarz glanz черный глянец	P60 biały połysk glossy whiteweiß glanz белый глянец
P61 czarny głęboki mat black deep matte effect tiefschwarz глубокий черный матовый	X0 plexi plexiglas плексиглас	A1 anoda naturalna anodized natural natur eloxiert серебристый анодированный алюминий	A11 anoda szorstkowana anodized brushed edelstahleffekt eloxiert эффект благородной стали

modern 41 - 50



standard 51 - 57

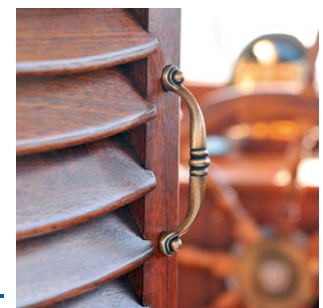



PREMIUM

LUKSUS I ELEGANCJA



Twix

Jeden uchwyt, wiele możliwości...

One product, many possibilities...

Ein Griff, viele Möglichkeiten...

Одна ручка, много возможностей...



NEW

Twix

G2, P59, P60, TL20

	S	W	H	L	P
C-5455-1	160	14	34	170	25
C-5459-320-1	320	14	34	330	25



Twix

TL20-P59, P59-TL20; P59-G2
G2-P59, P60-P59, P59-P60

	S	W	H	L	P
C-5455	160	18	34	170	25
C-5459-320	320	18	34	330	25



Prestige

A1-G2; A11-G2, P59-G2, P60-G2

	S	W	H	L	P
C-4429-128	128	12	38	140	25
C-4429-160	160	12	38	172	25
C-4429-192	192	12	38	204	25
C-4429-320	320	12	38	332	25

*możliwość wykonania innych długości po ustaleniu indywidualnych warunków zakupu.
Od rozstawu 384 w standardzie występuje 3 stopka.

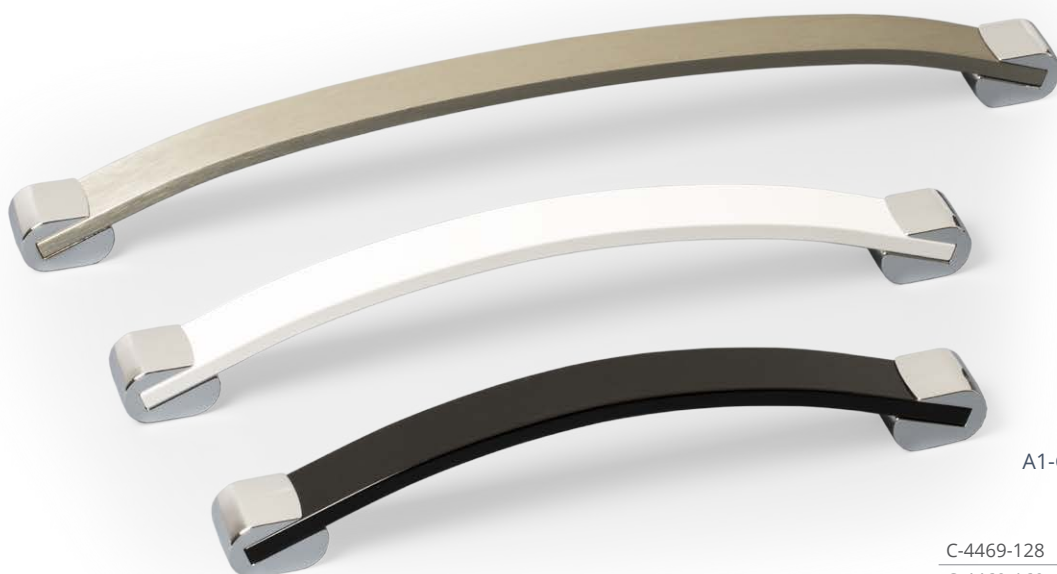

Fresco

A1-G2; A11-G2, P59-G2, P60-G2

	S	W	H	L	P
C-4469-128	128	18	28	165	25
C-4469-160	160	18	31	197	25
C-4469-192	192	18	33	229	25
C-4469-320	320	18	35	357	25

NEW



Aksis

A1-G2; G2-G2

	S	W	H	L	P
A-1522	-	25	30	35	25
C-5039-128	128	25	30	148	25
C-5039-160	160	25	30	180	25
C-5039-192	192	25	30	212	25
C-5039-224	224	25	30	244	25
C-5039-256	256	25	30	276	25
C-5039-320	320	25	30	340	25

X0-G2

	S	W	H	L	P
A-1522P	-	25	30	35	25
C-5039P-128	128	25	30	148	25
C-5039P-160	160	25	30	180	25
C-5039P-192	192	25	30	212	25

NEW

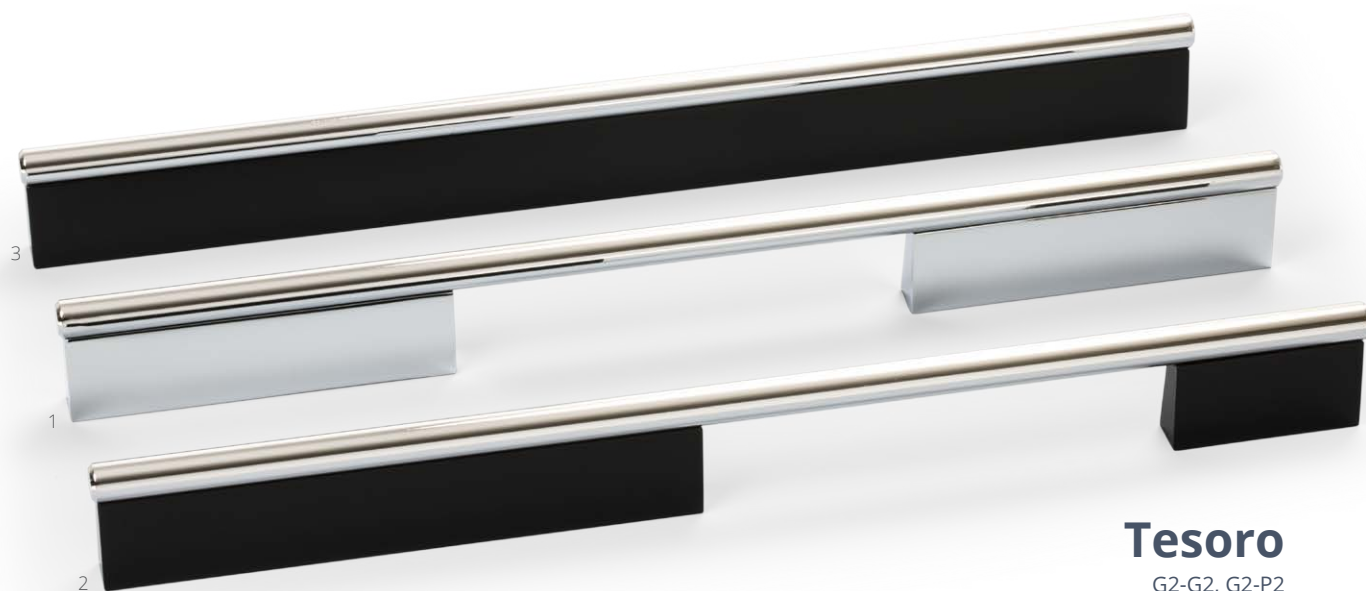

Tesoro

G2-G2, G2-P2

	S	W	H	L	P
1 C-5159-192/325	192	12	34	325	25
2 C-5169-192/325	192	12	34	325	25
3 C-5179-192/325	192	12	34	325	25

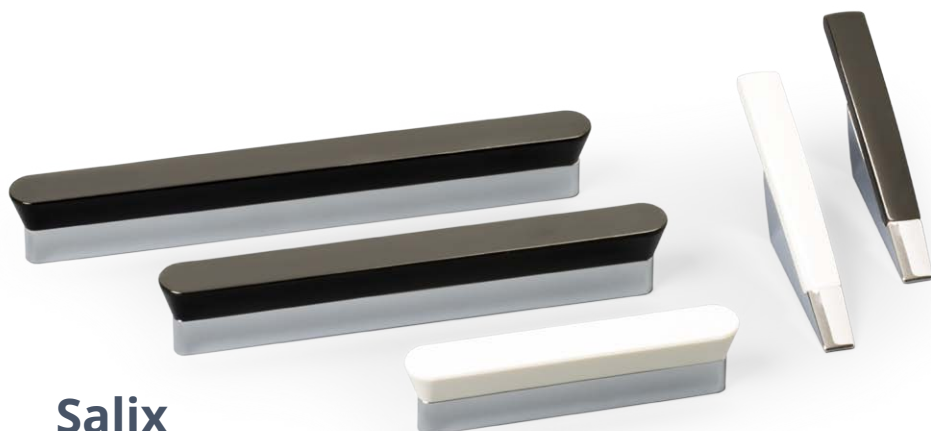

Salix

T1-G2, T10-G2

	S	W	H	L	P
C-3631	32	16	24	57	25
C-3633	96	17	24	116	25
C-3634	128	18	26	149	25
C-3635	160	18	26	181	25
C-3636	192	18	26	213	25
Z-5415	32	15	39	108	25



Encato

A1-G2; A11-G2, P59-G2, P60-G2

	S	W	H	L	P
C-4409-128	128	24	29	136	25
C-4409-160	160	24	29	168	25
C-4409-192	192	24	29	200	25
C-4409-320	320	24	29	328	25

*możliwość wykonania innych długości po ustaleniu indywidualnych warunków zakupu. Od rozstawu 384 w standardzie występuje 3 stopka.

Vigor

A1-G2; A11-G2, P59-G2, P60-G2

	S	W	H	L	P
C-4189-128	128	24	29	136	25
C-4189-160	160	24	29	168	25
C-4189-192	192	24	29	200	25
C-4189-320	320	24	29	328	25

*możliwość wykonania innych długości po ustaleniu indywidualnych warunków zakupu. Od rozstawu 384 w standardzie występuje 3 stopka.



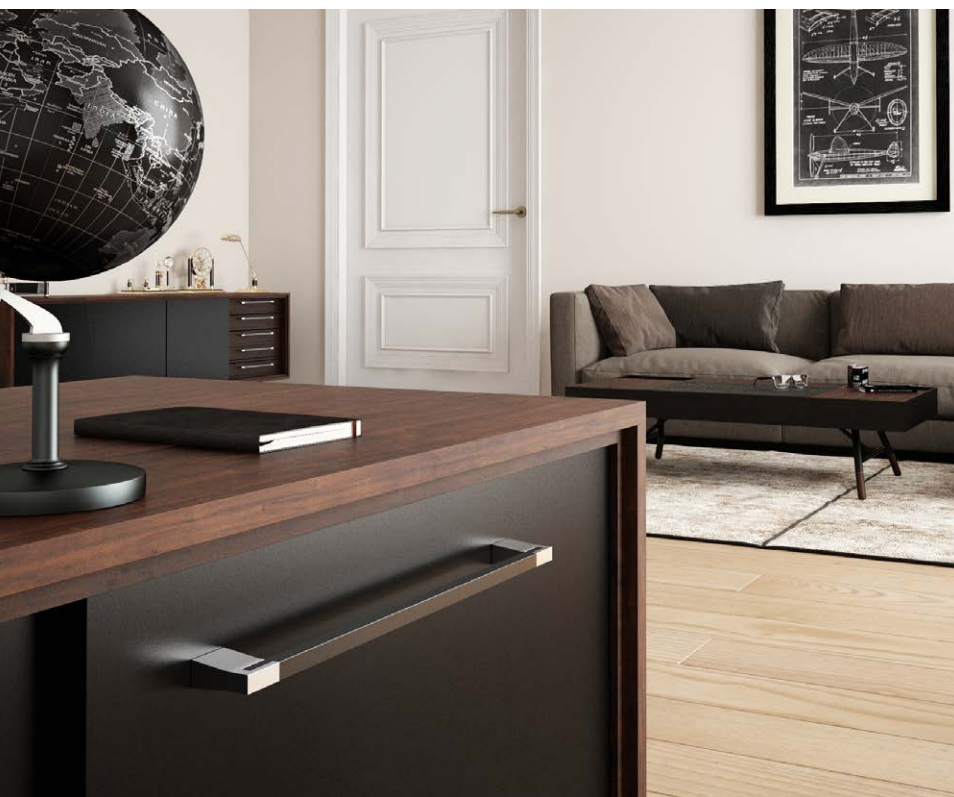

NEW

Pero

P59-G2; P60-G2

	S	W	H	L	P
C-5149-160	160	12	30	180	25
C-5149-256	256	12	30	276	25
C-5149-320	320	12	30	340	25



Viva

A1-G2; A11-G2, P59-G2, P60-G2

	S	W	H	L	P
C-4509-128	128	10	18	146	25
C-4509-160	160	10	18	178	25
C-4509-192	192	10	18	221	25
C-4509-320	320	10	18	338	25

*możliwość wykonania innych długości po ustaleniu indywidualnych warunków zakupu.



Lavice

A1-G6; G2-G2

	S	W	H	L	P
C-3809-128	128	18	29	146	25
C-3809-160	160	18	29	178	25
C-3809-192	192	18	29	210	25
C-3809-224	224	18	29	242	25
C-3809-256	256	18	29	274	25
C-3809-320	320	18	29	338	25
C-3809-384	384	18	29	402	25

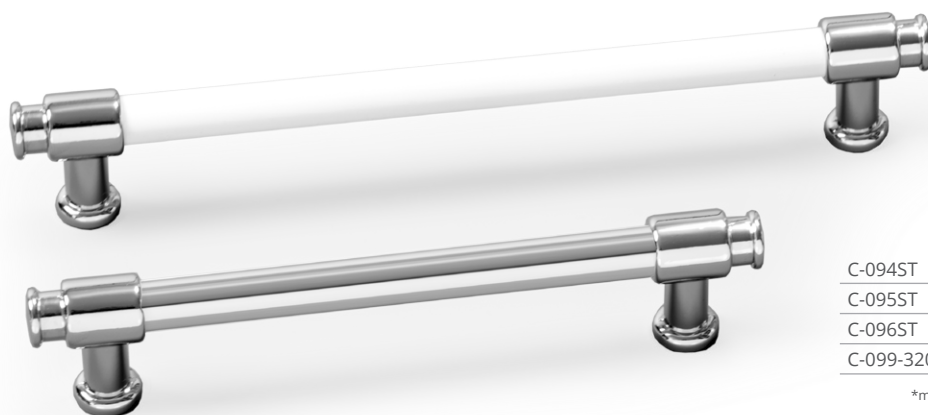

Galium

G2-G2; G4-G4, G8-G2; P60-G2

	S	W	H	L	P
C-094ST	128	14	30	158	25
C-095ST	160	14	30	190	25
C-096ST	192	14	30	222	25
C-099-320ST	320	14	30	350	25

*możliwość wykonania innych długości po ustaleniu indywidualnych warunków zakupu.

NEW



Pablo

P60-G2, P61-G2

	S	W	H	L	P
C-5509-128	128	12	30	140	25
C-5509-160	160	12	30	172	25
C-5509-192	192	12	30	204	25
C-5509-320	320	12	30	332	25

*możliwość wykonania innych długości po ustaleniu indywidualnych warunków zakupu.



NEW



Tavolo

G2, G49

	S	W	H	L	P
A-1552	-	24	27	26	25
C-5265	160	24	27	184	25

** dostępne od 04.2016r.



Clip

G2

	S	W	H	L	P
C-3536	192	23	29	200	25

NEW



Letto

G2, G5, G6, G8, G49

	S	W	H	L	P
C-5065	160	11	34	203	25
C-5069-320	320	11	34	363	25



Asser

G2

	S	W	H	L	P
C-3314	128	31	31	135	25
C-3318	256	31	31	263	25



Teres

G2

	S	W	H	L	P
C-4565	160	22	26	276	25

NEW

SWAROVSKI



Altare

G6, G49, P61

	S	W	H	L	P
A-1532	-	25	24	25	25
C-5193	96	25	23	104	25
C-5195	160	25	23	168	25



Legato

G2-G2

	S	W	H	L	P
C-3363	96	25	30	161	25
C-3365	160	25	30	225	25
C-3366	192	25	30	257	25
C-3367	224	25	30	289	25
C-3368	256	25	30	321	25
C-3369-320	320	25	30	385	25
C-3369-384	384	25	30	449	25





Altro

G2

	S	W	H	L	P
C-3710	16	59	21	59	10
C-3711	32	90	24	90	10



Fivela

G2

	S	W	H	L	P
C-4005	128/160	10	30	230	25



Aris

G2, G6, G8

	S	W	H	L	P
C-4519Z-128	128	12	22	148	25



Jazz

G2

	W	H	L	P
C-3042	85	30	84	10



Deep

G2

	S	W	H	L	P
Z-5408	32	60	60	180	10



Pumpin

G2, G6, G8

	W	H	L	P
C-3031	70	26	80	10

NEW

Skomponuj swój uchwyt wg schematu:

Compose your handle according to the scheme:
Gestalte Deinen Griff nach dem Schema:
Спроектируй себе сам ручку по схеме:

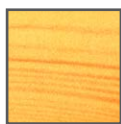

DF1

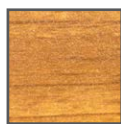

DF2



DF3

DF1 - sosna / pine / Kiefer / сосна
DF2 - wiśnia / cherry / Kirsche / вишня
DF3 - dąb / oak / Eiche / дуб



C-4509-128.DF1-P61

INDEX

DF

G



G2



G5



G8



P61



Viva

	S	W	H	L	P
C-4509-128	128	10	18	146	25
C-4509-160	160	10	18	178	25
C-4509-192	192	10	18	221	25
C-4509-320	320	10	18	338	25

Prestige

	S	W	H	L	P
C-4429-128	128	12	38	140	25
C-4429-160	160	12	38	172	25
C-4429-192	192	12	38	204	25
C-4429-320	320	12	38	332	25

*możliwość wykonania innych długości po ustaleniu indywidualnych warunków zakupu.
Od rozstawu 384 w standardzie występuje 3 stopka.



Cantina

	S	W	H	L	P
C-3294	128	10	36	138	25
C-3295	160	10	36	170	25
C-3296	192	10	36	202	25
C-3299-320	320	10	36	330	25

*możliwość wykonania innych długości po ustaleniu indywidualnych warunków zakupu.
** istnieje możliwość wykonania uchwytu z adapterem.



Vigor

	S	W	H	L	P
C-4189-128	128	24	29	136	25
C-4189-160	160	24	29	168	25
C-4189-192	192	24	29	200	25
C-4189-320	320	24	29	328	25

*możliwość wykonania innych długości po ustaleniu indywidualnych warunków zakupu.
Od rozstawu 384 w standardzie występuje 3 stopka.



Encato

	S	W	H	L	P
C-4409-128	128	24	29	136	25
C-4409-160	160	24	29	168	25
C-4409-192	192	24	29	200	25
C-4409-320	320	24	29	328	25

*możliwość wykonania innych długości po ustaleniu indywidualnych warunków zakupu.
Od rozstawu 384 w standardzie występuje 3 stopka.





NEW

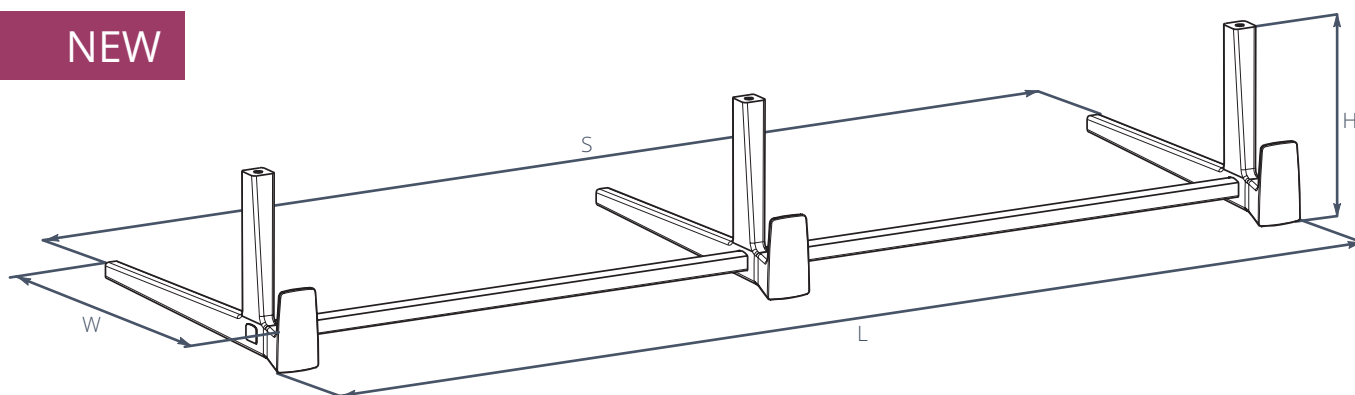

Alvero

G2, G6

	S	W	H	L	P
Z-6823-680	680	220	111	699	1

** dostępne od 04.2016r.

	S	W	H	L	P
A-1542	-	21	30	26	25
Z-5423	16	29	31	63	25

** dostępne od 04.2016r.





ALUMINIUM

ODWAGA I NOWOCZESNOŚĆ

NEW



Nolan

A1, A11, G2

	S	L	P
C-5519A-158	128	158	25
C-5519A-190	160	190	25
C-5519A-222	192	222	25
C-5519A-286	256	286	25
C-5519A-350	320	350	25

*możliwość wykonania innych długości po ustaleniu indywidualnych warunków zakupu.
** dostępne od 04.2016r.

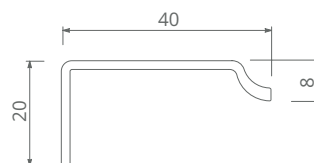

NEW



Altra

A1, A11, G2

	S	L	P
C-5529A-158	128	158	25
C-5529A-190	160	190	25
C-5529A-222	192	222	25
C-5529A-286	256	286	25
C-5529A-350	320	350	25

*możliwość wykonania innych długości po ustaleniu indywidualnych warunków zakupu.
** dostępne od 04.2016r.

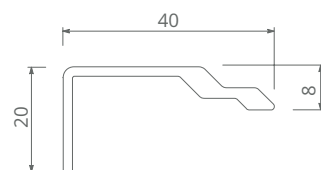

20

ODWAGA I NOWOCZESNOŚĆ
ALUMINIUM

NEW



Tonga

A1, A11, G2

	S	L	P
C-5539A-158	128	158	25
C-5539A-190	160	190	25
C-5539A-222	192	222	25
C-5539A-286	256	286	25
C-5539A-350	320	350	25

*możliwość wykonania innych długości po ustaleniu indywidualnych warunków zakupu.
** dostępne od 04.2016r.

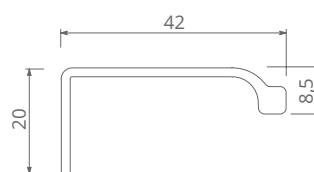

Costa

A1, A11, G2

	S	L	P
C-4789A-94	64	94	25
C-4789A-126	96	126	25
C-4789A-158	128	158	25
C-4789A-190	160	190	25
C-4789A-222	192	222	25
C-4789A-286	256	286	25
C-4789A-350	320	350	25

*możliwość wykonania innych długości po ustaleniu indywidualnych warunków zakupu.

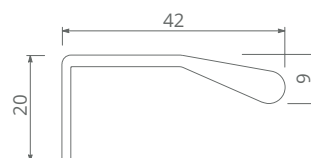



Highway

A1, A11, G2

	L	P
C-3590-146	146	1
C-3590-196	196	1
C-3590-246	246	1
C-3590-296	296	1
C-3590-346	346	1
C-3590-396	396	1
C-3590-446	446	1
C-3590-496	496	1
C-3590-596	596	1
C-3590-696	696	1
C-3590-796	796	1
C-3590-896	896	1
C-3590-996	996	1
C-3590-1096	1096	1
C-3590-1196	1196	1

*możliwość wykonania innych długości po ustaleniu indywidualnych warunków zakupu.

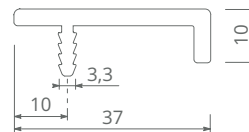

Vera

A1, A11, G2

	S	L	P
C-4909A-94	64	94	25
C-4909A-126	96	126	25
C-4909A-158	128	158	25
C-4909A-190	160	190	25
C-4909A-222	192	222	25
C-4909A-286	256	286	25
C-4909A-350	320	350	25

*możliwość wykonania innych długości po ustaleniu indywidualnych warunków zakupu.

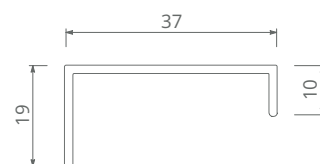



Terra

A1, A11, G2

	S	L	P
C-5000A-158	128	158	25
C-5000A-190	160	190	25
C-5000A-222	192	222	25
C-5000A-286	256	286	25
C-5000A-350	320	350	25

*możliwość wykonania innych długości po ustaleniu indywidualnych warunków zakupu.

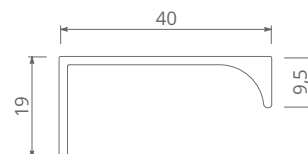



Fado

A1, A11

	S	L	P
C-2360-148	128	148	25
C-2360-180	160	180	25
C-2360-212	192	212	25
C-2360-276	256	276	25
C-2360-340	320	340	25

*możliwość wykonania innych długości po ustaleniu indywidualnych warunków zakupu.

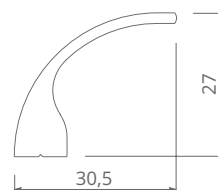

Veleno

A1, A11

	S	L	P
C-5080-148	128	148	25
C-5080-180	160	180	25
C-5080-212	192	212	25
C-5080-276	256	276	25
C-5080-340	320	340	25

*możliwość wykonania innych długości po ustaleniu indywidualnych warunków zakupu.

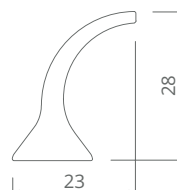

Tiro

A1, A11

	S	L	P
C-5370-148	128	148	25
C-5370-180	160	180	25
C-5370-212	192	212	25
C-5370-276	256	276	25
C-5370-340	320	340	25

*możliwość wykonania innych długości po ustaleniu indywidualnych warunków zakupu.

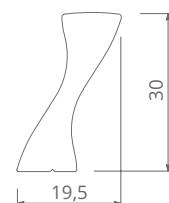



Vena

A1, A11

	S	L	P
C-5020-148	128	148	25
C-5020-180	160	180	25
C-5020-212	192	212	25
C-5020-276	256	276	25
C-5020-340	320	340	25

*możliwość wykonania innych długości po ustaleniu indywidualnych warunków zakupu.

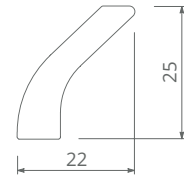

Avere

A1, A11, G2

	S	L	P
C-5010-148	128	148	25
C-5010-180	160	180	25
C-5010-212	192	212	25
C-5010-276	256	276	25
C-5010-340	320	340	25

*możliwość wykonania innych długości po ustaleniu indywidualnych warunków zakupu.

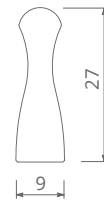

Essen

A1, A11

	S	L	P
C-2020-148	128	148	25
C-2020-180	160	180	25
C-2020-212	192	212	25
C-2020-276	256	276	25
C-2020-340	320	340	25

*możliwość wykonania innych długości po ustaleniu indywidualnych warunków zakupu.

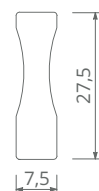



Malta

A1, A11

	S	L	P
C-2050-148	128	148	25
C-2050-180	160	180	25
C-2050-212	192	212	25
C-2050-276	256	276	25
C-2050-340	320	340	25

*możliwość wykonania innych długości po ustaleniu indywidualnych warunków zakupu.

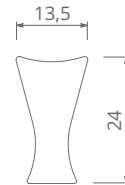

Makao

A1, A11

	S	L	P
C-1760-148	128	148	25
C-1760-180	160	180	25
C-1760-212	192	212	25
C-1760-276	256	276	25
C-1760-340	320	340	25

*możliwość wykonania innych długości po ustaleniu indywidualnych warunków zakupu.



Latino

A1, A11

	S	L	P
C-1770-148	128	148	25
C-1770-180	160	180	25
C-1770-212	192	212	25
C-1770-276	256	276	25
C-1770-340	320	340	25

*możliwość wykonania innych długości po ustaleniu indywidualnych warunków zakupu.

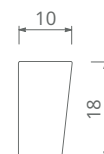



VINTAGE

PONADczasowy styl

NEW



Libretto

G49

	S	W	H	L	P
C-5180	16	16	25	26	25
C-5183	96	22	24	111	25
C-5184	128	22	24	143	25
C-5185	160	22	26	175	25
Z-5421	-	22	28	54	25

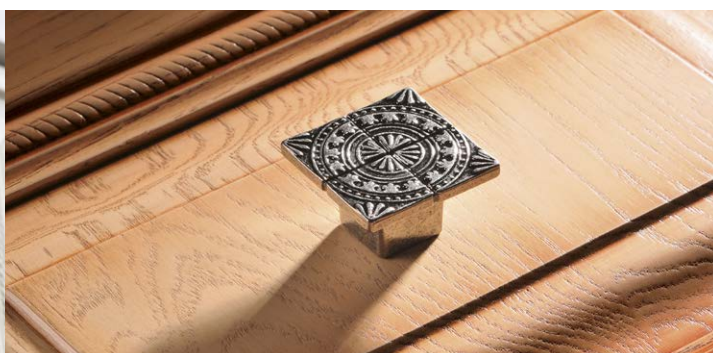

Sparta

G4, G35

	S	W	H	L	P
A-1434	-	38	23	-	25
C-3264	128	38	23	155	25
Z-5413	32	42	59	174	25



NEW



Fiore

G4, G49

	S	W	H	L	P
C-5111	32	37	29	40	25
C-5114	128	24	29	136	25

NEW



SWAROVSKI

Tanza

K1-G35M

	W	H	L	P
A-1393	20	22	28	10



Perseus

G4

	S	W	H	L	P
A-1053	-	25	27	-	100
E-580	37	21	-	45	100



NEW



Caldo

G4, G49

	S	W	H	L	P
C-5101	32	35	28	40	25
C-5104	128	24	28	135	25



Ashema

G4, G5, G6

	S	W	H	L	P
C-192	64	27	20	94	50

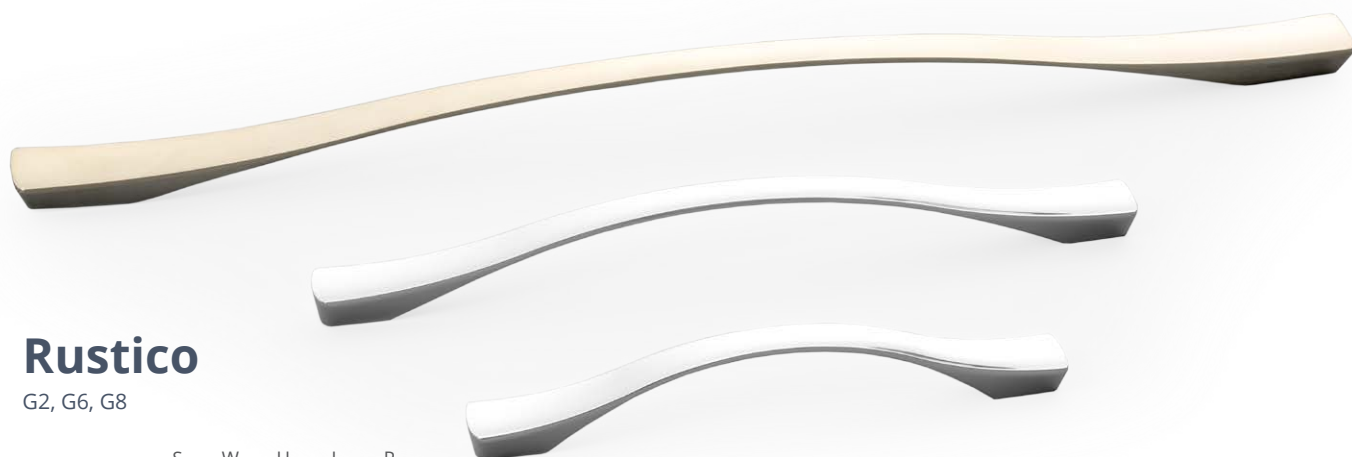

Rustico

G2, G6, G8

	S	W	H	L	P
C-3814	128	16	27	150	50
C-3815	160	16	29	182	50
C-3816	192	16	29	214	50
C-3818	256	19	30	299	50
C-3819-320	320	20	31	363	25



Ansa

T1-G2, T10-G2

	S	W	H	L	P
C-3444	128	25	33	169	100

Pinus

T1-G2, T10-G2

	W	H	L	P
A-256	15	26	37	100



Clio

G4, G49, P61

	S	W	H	L	P
C-1973	96	24	26	140	100

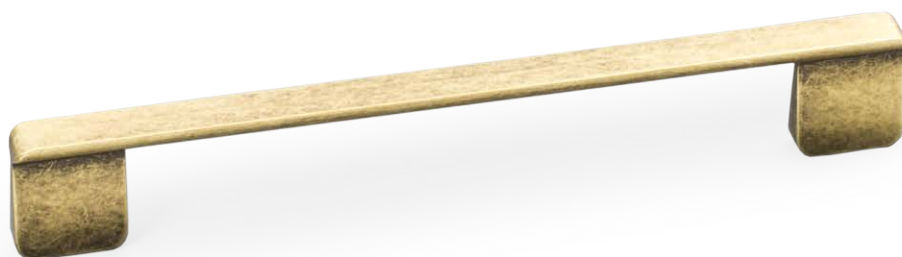
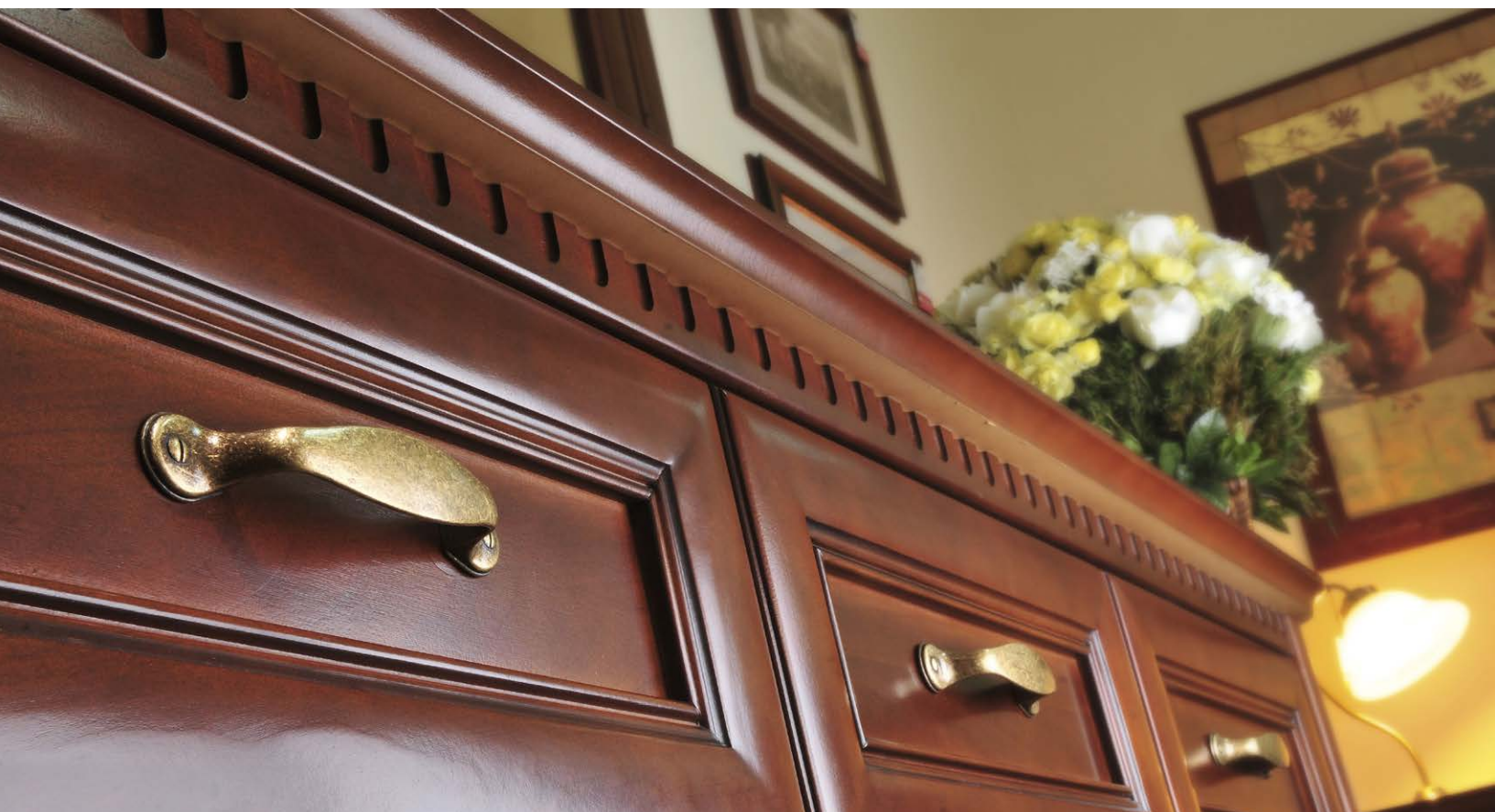

Ordo

G2 G4, G5, G6

	S	W	H	L	P
C-4435	160	10	28	183	25

Nyja

G4, G49

	S	W	H	L	P
C-1983	96	16	28	112	100



NEW



Armado

G2, G6, G8, G49

	S	W	H	L	P
C-5305	160	14	35	179	25



Cerber

G4, G49

	S	W	H	L	P
C-1553	96	16	32	114	100

Zeus

G4, G49

	S	W	H	L	P
C-2943	96	23	24	150	100





Chorus

G4, G49

	S	W	H	L	P
C-3052	64	35	25	76	50

G4, G6, G49

	S	W	H	L	P
Z-5409	32	60	179	68	25



Z-5402

Sol

G4

	S	W	H	L	P
Z-5402	23	41	31	65	50
Z-5401	23	72	82	191	25



Z-5401



CLASSIC

HARMONIA, RÓWNOWAGA, SPOKÓJ

Toronto

G2, G5, G6, G8, G49, P59, P60

	Ø	H	P
A-823	31	29	100



Napoli

G2, G5, G6, G4, G8, P59, P60

	W	H	L	P
A-325	23	27	36	100



Golden Gate

G2, G6, G8

	S	W	H	L	P
C-3475	160	18	26	228	50
C-3479-320	320	18	26	388	25

NEW



Fede

G2, G6, G8, G49

	S	W	H	L	P
C-5275	160	9	35	178	25

Enel

G2, G5, G6, G8

	S	W	H	L	P
C-4474	128	14	33	149	50
C-4475	160	15	37	183	50
C-4476	192	15	37	219	50
C-4478	256	15	37	293	50

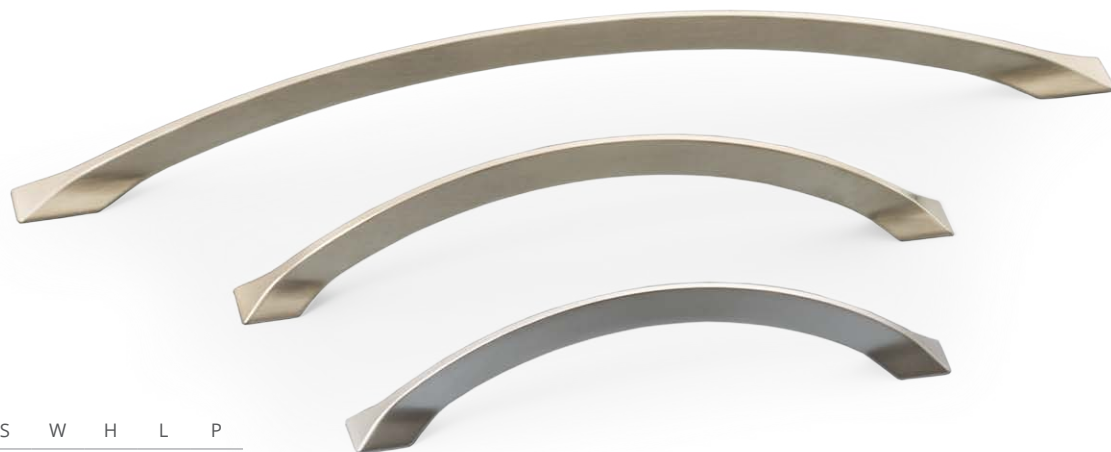

Noak

G2, G5, G6, G8

	S	W	H	L	P
C-4484	128	15	32	145	50
C-4485	160	15	32	177	50
C-4486	192	15	32	209	50
C-4489-320	320	15	32	337	25

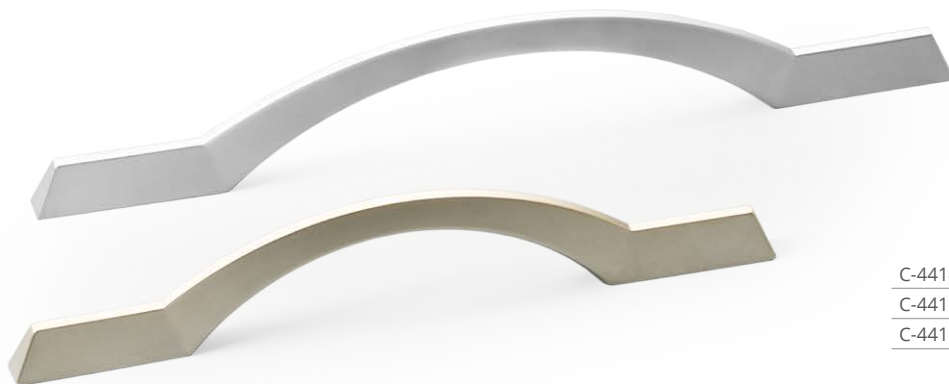

Pectus

G2, G6

	S	W	H	L	P
C-4414	128	8	29	165	50
C-4415	160	8	33	207	50
C-4419-320	320	8	37	337	25



Fibbia

G2, G5, G8

	S	W	H	L	P
C-3824	128	14	30	173	50
C-3825	160	15	32	209	50
C-3826	192	15	32	241	50
C-3827	224	15	32	273	50
C-3828	256	15	32	302	50
C-3829-320A	320	15	32	366	25



Songo

G2, G6, G8, P59

	S	W	H	L	P
C-3484	128	20	25	145	50
C-3485	160	20	26	177	50
C-3486	192	22	27	209	50
C-3488	256	23	27	273	50
C-3489-320	320	26	29	337	25



Alternative

G2, G5, G6, G8

	S	W	H	L	P
C-3274	128	10	31	192	50
C-3278	256	10	31	318	25



Ve

G2, G6

	S	W	H	L	P
C-4495	160	23	29	182	25
C-4498	256	23	29	278	25



NEW

Verne

G2, G6, G8, G4, G49

	S	W	H	L	P
C-5074	128	20	26	168	25
C-5075	160	20	28	200	25

NEW



Libro

G2, G6, G8

	S	W	H	L	P
C-5053	96	12	25	134	25
C-5055	160	14	27	198	25



Yukon

G2, G4, G5, G6

	S	W	H	L	P
Z-361	20	78	30	47	50



Celebes

G2, G4, G5, G6

	S	W	H	L	P
Z-375	20	78	77	125	50



Z-355

Argus

G2, G5, G6

	S	W	H	L	P
Z-341	32	78	32	58	50
Z-355	32	78	65	148	50



Z-341



Ontario

G2, G4, G5, G6

	Fi	W	H	L	P
Z-422	12		35	28	100
Z-423	15		44	33	100



Dominica

G2, G4, G5, G6

	S	W	H	L	P
Z-391	18	58	29	32	100





MODERN

SPOJRZENIE W PRZYSZŁOŚĆ



Calypso

G2, G5, G6

	W	H	L	P
A-1405	55	24	55	10

kolor wkładki:



Trip Hop

G2, G5, G6

	W	H	L	P
A-1415	60	24	60	10

kolor wkładki:



Grime

G2, G5, G6

	Ø	H	P
A-1425	60	25	10

kolor wkładki:



Big Beat

G4-G2, G5-G2, G6-G2, G8-G2, P1-G2, P2-G2

	H	L	P
A-1465	24	57	10



Ars Nova

G4-G2, G5-G2, G6-G2, G8-G2, P1-G2, P2-G2

	Ø	H	P
A-1455	61	25	10



Blues

G2, G5, G6

	W	H	L	P
A-1313	45	22	45	50

NEW



Fondo

G6, G49

	S	W	H	L	P
C-5361	32	8	25	41	50

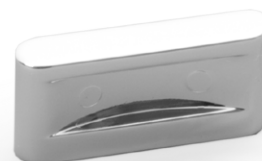

Caracas

G2, TL2

	S	W	H	L	P	TL2
C-2331	32	8	20	42	50	■



Liberc

G2, G6

	Ø	H	P
A-1294	30	20	50



Celer

G5, G6

	S	W	H	L	P
C-1751	32	35	17	44	50
C-1753	96	42	17	108	50
C-1755	160	42	17	174	25



Quadrum

G5, G6

	W	H	L	P
A-1135	45	17	45	25

Solea

G2, G6

	S	W	H	L	P
C-4132	64	50	21	85	25
C-4134	128	50	21	149	25

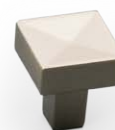
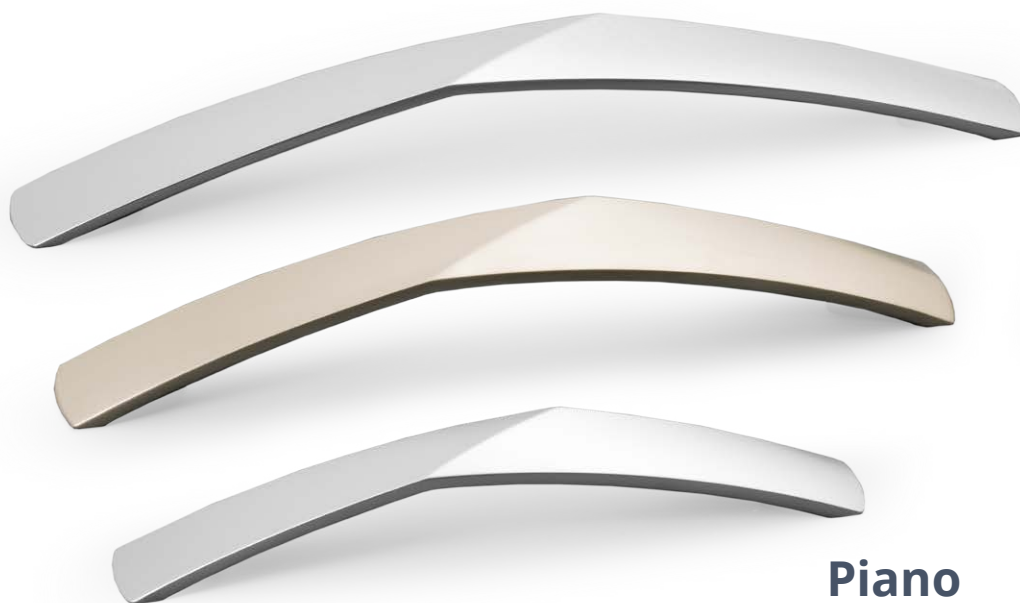
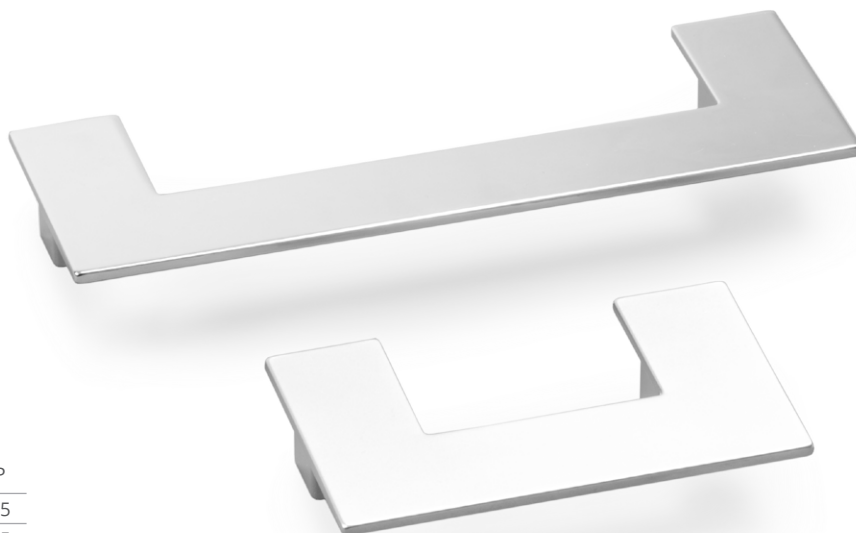

Reggae

G2, G5, G6

	W	H	L	P
A-1272	20	23	20	100

Piano

G2, G5, G6, G8

	S	W	H	L	P
C-3504	128	21	26	168	50
C-3505	160	26	33	210	50
C-3506	192	26	35	250	50

Frotto

G2, G6, G8, P59, P60

	S	W	H	L	P
C-3839Z-128	128	7	25	144	50
C-3839Z-160	160	7	25	176	50
C-3839Z-192	192	7	25	208	50
C-3839Z-224	224	7	25	240	50
C-3839Z-320	320	7	25	336	25



Techno

G2, G5, G6, G8, G49, P59, P60

	S	W	H	L	P
C-761	32	8	26	57	100
C-763	96	8	28	130	100
C-764	128	8	27	150	50
C-765	160	8	28	193	50
C-766	192	8	28	226	50
C-768	256	8	28	289	50
C-769-320	320	8	28	354	25



gałko-wieszak **Laiko**

G2, G5, G6, G8, G49, P59, P60

	S	W	H	L	P
A-892	12	8	18	40	100

*Dieses Angebot gilt nicht für das Gebiet der Bundesrepublik Deutschland.

Techno

G2, G5, G6, G8

	S	W	H	L	P
C-1143	96	9	30	137	100
C-1144	128	9	30	169	50
C-1146	160/192	9	30	204	50



NEW

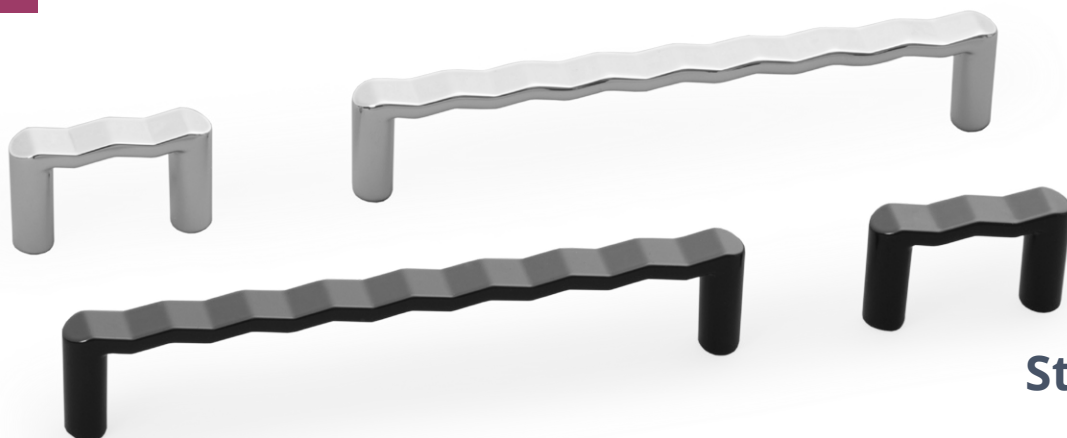

Strada

G2, P59

	S	W	H	L	P
C-5121	32	10	25	42	25
C-5124	128	10	25	137	25

NEW

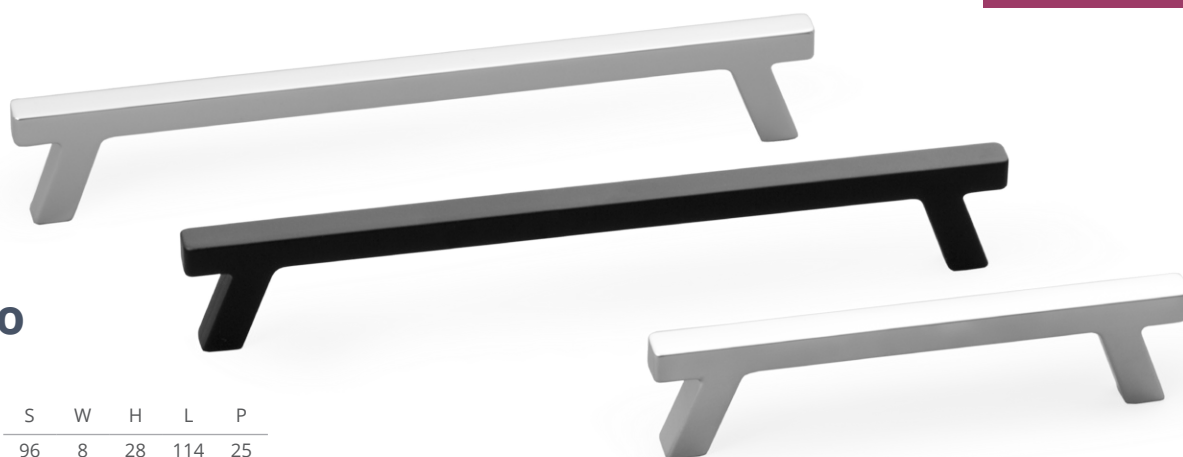

Verico

G2, G6, P61

	S	W	H	L	P
C-5293	96	8	28	114	25
C-5295	160	8	28	178	25

NEW



Amaro

G2, G6, G49, P61

	S	W	H	L	P
C-5285	160	14	29	174	25
C-5286	192	14	29	206	25
C-5289-320	320	14	29	334	25



Tratto

G2

	S	W	H	L	P
C-5444	128	9	17	138	50

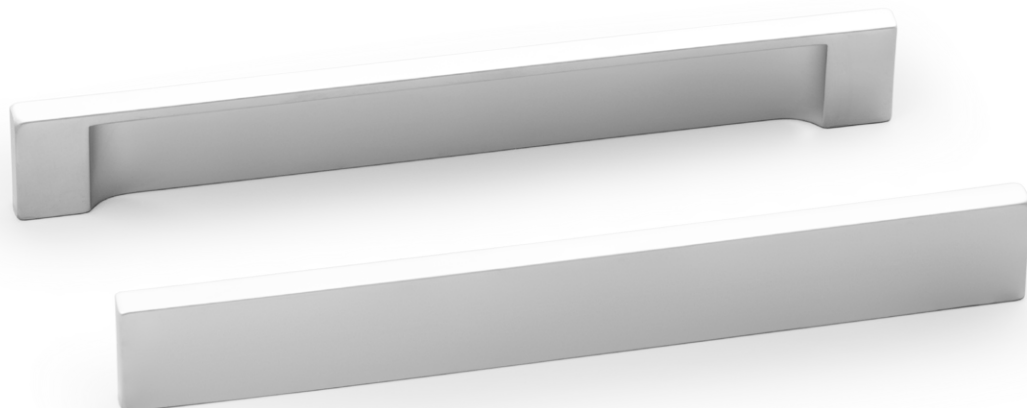

Pronus

G2, G6

	S	W	H	L	P
C-4089Z-96	96	7	25	120	50
C-4089Z-128	128	7	25	152	50
C-4089Z-160	160	7	25	184	50
C-4089Z-192	192	7	25	216	50
C-4089Z-320	320	7	25	344	25



Dubstep

G5, G6, G8, P59

	S	W	H	L	P
C-1881	32	9	18	48	100
C-1883	96	9	18	140	100



Fuga

G2, G5, G6, G8

	S	W	H	L	P
C-3135	128/160	8	32	215	50
C-3137	224	8	32	250	25



Left Field

G2, G5, G6, G8

	S	W	H	L	P
C-3147	224	8	32	250	25



House

G2, G5, G6, G8

	S	W	H	L	P
C-2951	32	8	34	55	100
C-2954	128	8	34	151	50
C-2955	160	8	34	183	50
C-2957	224	8	34	247	50
C-2958	256	8	34	279	50
C-2959-320	320	8	34	343	25



NEW

Arto

G2, G6

	S	W	H	L	P
Z-5426	16	34	51	79	25



NEW

Vinella

G2, G4

	W	H	L	P
B-160	16	50	50	25



Ska

G2, G6

	S	W	H	L	P
A-955	-	50	18	22	50
C-1891	32	50	18	50	50
C-1892	64	50	18	80	50

Louisiana

G2, G5, G6, G8



	∅	∅	H	P
Z-5412	25	18	47	100



gałko-wieszak

Cartagena

G6

	∅	H	P
A-995A	20	50	100



STANDARD

PROSTOTA I ŁAD



Hestia

G4

	Ø	W	H	L	P
A-013	25	-	23	-	100
E-450	-	34	-	63	100



Demeter

G4

	W	H	L	P
A-025	20	21	35	100
E-460	25	-	79	100



Ikar

G4, G49

	Ø	H	P
A-1014	30	22	100



Mars

G4

	W	H	L	P
B-090	63	17	51	100



Hino

G4

	W	H	L	P
B-070	35	16	55	100



Soho

G4

	W	H	L	P
B-150	25	20	58	100



Bachus

G4

	S	W	H	L	P
C-1003	96	15	29	111	100



Kronos

G4

	S	W	H	L	P
C-293	96	14	24	135	100

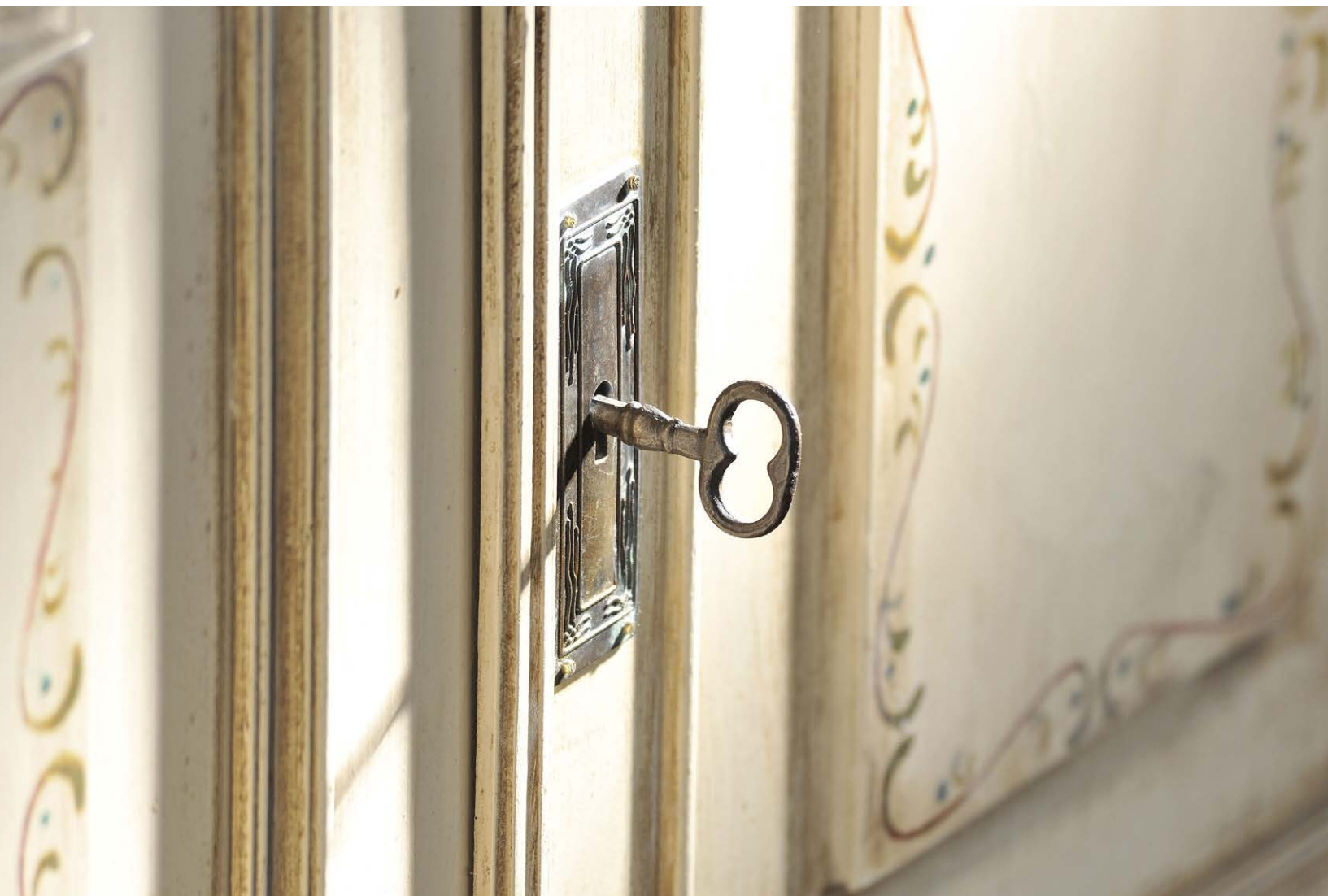

B-100



E-370



D-062

Leda

G4

	S	W	H	L	P
B-100	-	34	17	97	100
E-370	-	34	3	97	100
D-062	64	43	17	97	100



Milan

G2, G4, G5, G6, P59, P60

	W	H	L	P
A-246	27	26	37	100



Ambient

G2, G5, G6, G8

	Ø	H	P
A-312	25	25	100



Virgo

G5, G6

	Ø	H	P
A-464	28	23	100



Sydney

G2, G5, G6, P59, P60

	Ø	H	P
A-400	24	20	100



Plymouth

G2, G5, G6

	S	W	H	L	P
C-2701	32	14	46	44	50

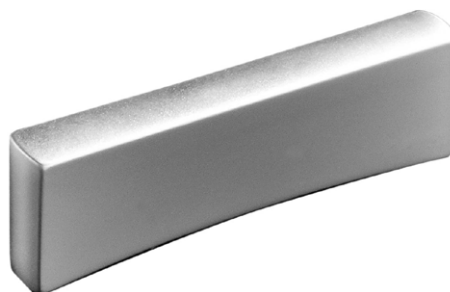

Daina

G2, G5, G6

	S	W	H	L	P
C-3232	64	9	24	75	25



Baltic

G2, G6

	S	W	H	L	P
C-451	32	20	20	41	100

Pasto

G6

	S	W	H	L	P
C-962	64	21	20	102	100



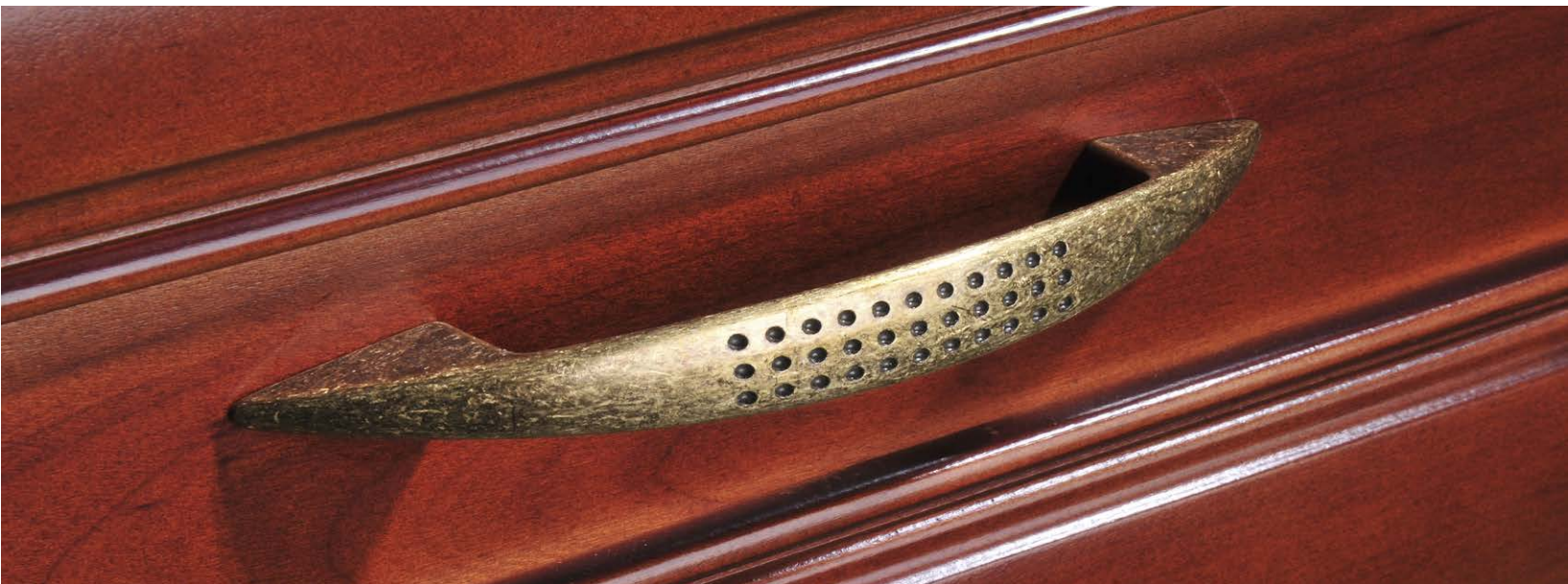

Argus

G2, G4, G5, G6

	S	W	H	L	P
C-313A	96	16	29	133	100
C-314	128	16	29	165	100



Victoria

G2, G6

	S	W	H	L	P
C-2123	96	17	23	138	50
C-2124	128	23	24	184	50



Georgia

G2, G5, G6

	S	W	H	L	P
C-173A	96	10	28	126	100
C-174	128	10	30	157	100



Porto

G5, G6

	S	W	H	L	P
C-3074	128	15	26	136	50
C-3076	192	19	29	202	50



Monaco

G5, G6

	S	W	H	L	P
C-074	128	19	23	141	100



Regulus

G5, G6

	S	W	H	L	P
C-1083	96	13	25	105	100
C-1084	128	13	26	137	100



Fornax

G5, G6

	S	W	H	L	P
C-1103	96	13	25	109	100
C-1104	128	13	27	141	100



Virgo

G5, G6

	S	W	H	L	P
C-1093	96	13	25	106	100
C-1094	128	13	27	138	100



Olivia

G2, G4, G5, G6

	S	W	H	L	P
C-503	96	12	24	127	100
C-504A	128	13	24	164	100



La Paz

G5, G6

	S	W	H	L	P
C-713	96	15	24	129	100
C-714	128	15	25	158	100



Arco

G2, G4, G5, G6

	S	W	H	L	P
C-622	64	10	24	81	100
C-623	96	10	25	115	100
C-624	128	11	28	160	100



Santa Cruz

G2, G5, G6, G8

	S	Ø	H	L	P
C-2100-156	96	12	32	156	20
C-2100-188	128	12	32	188	20
C-2100-208	128	12	32	208	20
C-2100-220	160	12	32	220	20
C-2100-240	160	12	32	240	20
C-2100-272	192	12	32	272	20
C-2100-304	224	12	32	304	20
C-2100-356	256	12	32	356	20
C-2100-368	288	12	32	368	20
C-2100-400	320	12	32	400	20
C-2100-432	352	12	32	432	20
C-2100-464	384	12	32	464	20
C-2100-496	416	12	32	496	20
C-2100-528	448	12	32	528	20
C-2100-560	480	12	32	560	10
C-2100-592	512	12	32	592	10
C-2100-624	544	12	32	624	10
C-2100-656	576	12	32	656	10
C-2100-752	672	12	32	752	10



Tribal

G2, G5, G8

	S	W	H	L	P
C-3374	128	9	22	159	50



Lahti

G5, G6

	S	W	H	L	P
C-2044	128	11	33	168	50



Galway

G5, G6

	S	W	H	L	P
C-1743	96	13	23	141	100

Spis treści wg nazwy

Aksis	7	Fornax	56	Prestige	6
Altare	13	Fresco	6	Prestige	17
Alternative	38	Frotto	45	Pronus	47
Altra	20	Fuga	48	Pumpin	15
Altro	14	Galium	10	Quadrum	43
Alvero	18	Galway	57	Reggae	44
Amaro	46	Georgia	55	Regulus	56
Ambient	54	Golden Gate	35	Rustico	30
Ansa	30	Grime	42	Salix	8
Arco	56	Hestia	52	Santa Cruz	57
Argus	40	Highway	22	Ska	50
Argus	55	Hino	52	Soho	52
Aris	14	House	48	Sol	33
Armado	32	Ikar	52	Solea	44
Ars Nova	42	Jazz	15	Songo	37
Arto	49	Kronos	52	Sparta	28
Ashema	30	Lahti	57	Strada	46
Asser	12	Laiko	45	Sydney	54
Avere	25	La Paz	56	Tanza	29
Bachus	52	Latino	26	Tavolo	11
Baltic	54	Lavice	10	Techno	45
Big Beat	42	Leda	53	Techno	45
Blues	42	Left Field	48	Teres	12
Caldo	29	Legato	13	Terra	23
Calypso	42	Letto	12	Tesoro	7
Cantina	17	Liberc	43	Tiro	24
Caracas	43	Libretto	28	Tonga	21
Cartagena	50	Libro	39	Toronto	35
Celebes	40	Louisiana	50	Tratto	47
Celer	43	Makao	26	Tribal	57
Cerber	32	Malta	26	Trip Hop	42
Chorus	33	Mars	52	Twix	5
Clio	31	Milan	54	Vea	39
Clip	11	Monaco	55	Veleno	24
Costa	21	Napoli	35	Vena	25
Daina	54	Noak	36	Vera	22
Deep	15	Nolan	20	Verico	46
Demeter	52	Nyja	32	Verne	39
Dominica	40	Olivia	56	Victoria	55
Dubstep	47	Ontario	40	Vigor	8
Encato	8	Ordo	31	Vigor	17
Encato	17	Pablo	10	Vinella	50
Enel	36	Pasto	54	Virgo	54
Essen	25	Pectus	36	Virgo	56
Fado	24	Pero	9	Viva	9
Fede	35	Perseus	29	Viva	16
Fibbia	37	Piano	44	Yukon	40
Fiore	29	Pinus	30	Zeus	32
Fivela	14	Plymouth	54		
Fondo	43	Porto	55		

Spis treści wg indeksu

A-013	52	C-503	56	C-2020-148	25
A-025	52	C-504A	56	C-2020-180	25
A-246	54	C-622	56	C-2020-212	25
A-256	30	C-623	56	C-2020-276	25
A-312	54	C-624	56	C-2020-340	25
A-325	35	C-713	56	C-2044	57
A-400	54	C-714	56	C-2050-148	26
A-464	54	C-761	45	C-2050-180	26
A-823	35	C-763	45	C-2050-212	26
A-892	45	C-764	45	C-2050-276	26
A-955	50	C-765	45	C-2050-340	26
A-995A	50	C-766	45	C-2100-156	57
A-1014	52	C-768	45	C-2100-188	57
A-1053	29	C-769-320	45	C-2100-208	57
A-1135	43	C-962	54	C-2100-220	57
A-1272	44	C-1003	52	C-2100-240	57
A-1294	43	C-1083	56	C-2100-272	57
A-1313	42	C-1084	56	C-2100-304	57
A-1393	29	C-1093	56	C-2100-356	57
A-1405	42	C-1094	56	C-2100-368	57
A-1415	42	C-1103	56	C-2100-400	57
A-1425	42	C-1104	56	C-2100-432	57
A-1434	28	C-1143	45	C-2100-464	57
A-1455	42	C-1144	45	C-2100-496	57
A-1522	7	C-1146	45	C-2100-528	57
A-1522P	7	C-1553	32	C-2100-560	57
A-1532	13	C-1743	57	C-2100-592	57
A-1542	18	C-1751	43	C-2100-624	57
A-1552	11	C-1753	43	C-2100-656	57
B-070	52	C-1755	43	C-2100-752	57
B-090	52	C-1760-148	26	C-2123	55
B-100	53	C-1760-180	26	C-2124	55
B-150	52	C-1760-212	26	C-2331	43
B-160	50	C-1760-276	26	C-2360-148	24
C-074	55	C-1760-340	26	C-2360-180	24
C-094ST	10	C-1770-148	26	C-2360-212	24
C-095ST	10	C-1770-180	26	C-2360-276	24
C-096ST	10	C-1770-212	26	C-2360-340	24
C-099-320ST	10	C-1770-276	26	C-2701	54
C-173A	55	C-1770-340	26	C-2943	32
C-174	55	C-1881	47	C-2951	48
C-192	30	C-1883	47	C-2954	48
C-293	52	C-1891	50	C-2955	48
C-313A	55	C-1892	50	C-2957	48
C-314	55	C-1973	31	C-2958	48
C-451	54	C-1983	32	C-2959-320	48

Spis treści wg indeksu

C-3031	15	C-3590-596	22	C-4189-128	17
C-3042	15	C-3590-696	22	C-4189-160	8
C-3052	33	C-3590-796	22	C-4189-160	17
C-3074	55	C-3590-896	22	C-4189-192	8
C-3076	55	C-3590-996	22	C-4189-192	17
C-3135	48	C-3590-1096	22	C-4189-320	8
C-3137	48	C-3590-1196	22	C-4189-320	17
C-3147	48	C-3631	8	C-4409-128	8
C-3232	54	C-3633	8	C-4409-128	17
C-3264	28	C-3634	8	C-4409-160	8
C-3274	38	C-3635	8	C-4409-160	17
C-3278	38	C-3636	8	C-4409-192	8
C-3294	17	C-3710	14	C-4409-192	17
C-3295	17	C-3711	14	C-4409-320	8
C-3296	17	C-3809-128	10	C-4409-320	17
C-3299-320	17	C-3809-160	10	C-4414	36
C-3314	12	C-3809-192	10	C-4415	36
C-3318	12	C-3809-224	10	C-4419-320	36
C-3363	13	C-3809-256	10	C-4429-128	6
C-3365	13	C-3809-320	10	C-4429-128	17
C-3366	13	C-3809-384	10	C-4429-160	6
C-3367	13	C-3814	30	C-4429-160	17
C-3368	13	C-3815	30	C-4429-192	6
C-3369-320	13	C-3816	30	C-4429-192	17
C-3369-384	13	C-3818	30	C-4429-320	6
C-3374	57	C-3819-320	30	C-4429-320	17
C-3444	30	C-3824	37	C-4435	31
C-3475	35	C-3825	37	C-4469-128	6
C-3479-320	35	C-3826	37	C-4469-160	6
C-3484	37	C-3827	37	C-4469-192	6
C-3485	37	C-3828	37	C-4469-320	6
C-3486	37	C-3829-320A	37	C-4474	36
C-3488	37	C-3839Z-128	45	C-4475	36
C-3489-320	37	C-3839Z-160	45	C-4476	36
C-3504	44	C-3839Z-192	45	C-4478	36
C-3505	44	C-3839Z-224	45	C-4484	36
C-3506	44	C-3839Z-320	45	C-4485	36
C-3536	11	C-4005	14	C-4486	36
C-3590-146	22	C-4089Z-96	47	C-4489-320	36
C-3590-196	22	C-4089Z-128	47	C-4495	39
C-3590-246	22	C-4089Z-160	47	C-4498	39
C-3590-296	22	C-4089Z-192	47	C-4509-128	9
C-3590-346	22	C-4089Z-320	47	C-4509-128	16
C-3590-396	22	C-4132	44	C-4509-160	9
C-3590-446	22	C-4134	44	C-4509-160	16
C-3590-496	22	C-4189-128	8	C-4509-192	9

Spis treści wg indeksu

C-4509-192	16	C-5069-320	12	C-5509-160	10
C-4509-320	9	C-5074	39	C-5509-192	10
C-4509-320	16	C-5075	39	C-5509-320	10
C-4519Z-128	14	C-5080-148	24	C-5519A-158	20
C-4565	12	C-5080-180	24	C-5519A-190	20
C-4789A-94	21	C-5080-212	24	C-5519A-222	20
C-4789A-126	21	C-5080-276	24	C-5519A-286	20
C-4789A-158	21	C-5080-340	24	C-5519A-350	20
C-4789A-190	21	C-5101	29	C-5529A-158	20
C-4789A-222	21	C-5104	29	C-5529A-190	20
C-4789A-286	21	C-5111	29	C-5529A-222	20
C-4789A-350	21	C-5114	29	C-5529A-286	20
C-4909A-94	22	C-5121	46	C-5529A-350	20
C-4909A-126	22	C-5124	46	C-5539A-158	21
C-4909A-158	22	C-5149-160	9	C-5539A-190	21
C-4909A-190	22	C-5149-256	9	C-5539A-222	21
C-4909A-222	22	C-5149-320	9	C-5539A-286	21
C-4909A-286	22	C-5159-192/325	7	C-5539A-350	21
C-4909A-350	22	C-5169-192/325	7	D-062	53
C-5000A-158	23	C-5179-192/325	7	E-370	53
C-5000A-190	23	C-5180	28	E-450	52
C-5000A-222	23	C-5183	28	E-460	52
C-5000A-286	23	C-5184	28	E-580	29
C-5000A-350	23	C-5185	28	Z-341	40
C-5010-148	25	C-5193	13	Z-355	40
C-5010-180	25	C-5195	13	Z-361	40
C-5010-212	25	C-5265	11	Z-375	40
C-5010-276	25	C-5275	35	Z-391	40
C-5010-340	25	C-5285	46	Z-422	40
C-5020-148	25	C-5286	46	Z-423	40
C-5020-180	25	C-5289-320	46	Z-5401	33
C-5020-212	25	C-5293	46	Z-5402	33
C-5020-276	25	C-5295	46	Z-5408	15
C-5020-340	25	C-5305	32	Z-5409	33
C-5039-128	7	C-5361	43	Z-5412	50
C-5039-160	7	C-5370-148	24	Z-5413	28
C-5039-192	7	C-5370-180	24	Z-5415	8
C-5039-224	7	C-5370-212	24	Z-5421	28
C-5039-256	7	C-5370-276	24	Z-5423	18
C-5039-320	7	C-5370-340	24	Z-5426	49
C-5039P-128	7	C-5444	47	Z-6823-680	18
C-5039P-160	7	C-5455	5		
C-5039P-192	7	C-5455-1	5		
C-5053	39	C-5459-320	5		
C-5055	39	C-5459-320-1	5		
C-5065	12	C-5509-128	10		

Zapraszamy do zapoznania się z naszą pozostałą ofertą:

WYROBY Z DRUTU (kosze cargo, garderoba)



KLAMKI



DIAMENT
 meblarstwa
 2016

							
As	Silva	Lea	Alva	Alto	Alex	Argus	Antilia
							
Apus	Carina	Cetus	Diana	Eva	Feniks	Inka	Katia
							
Laura	Marina	Pem	Pegaz	Regulus	Tom	Tucana	Vela
							
Wiki	Minos	Tarczki seria 100	Tarczki seria 104	Tarczki seria 109	Tarczki seria 112	Tarczki seria 115	Tarczki seria 120
							
Tarczki seria 121	Tarczki seria 123	Tarczki seria 124	Tarczki seria 125	Tuleje wentylacyjne do drzwi WC rozm. 38-45 mm	Tuleje wentylacyjne do drzwi WC rozm. 22-26 mm rozm. 31-41 mm rozm. 38-45 mm		



www.nomet.pl

NOMET Sp. z o.o.

ul. Kanałowa 40/42
87-100 Toruń

**Dział sprzedaży akcesoriów meblowych
oraz wyrobów z drutu:**

tel.: +48 56 619 81 11

tel.: +48 56 619 81 12

tel.: +48 56 619 81 35

tel.: +48 56 619 81 79

fax: +48 56 619 81 17

sprzedaz@nomet.pl

Dział klamek:

tel.: +48 56 619 82 16

tel.: +48 56 619 81 16

fax: +48 56 619 81 38

klamki@nomet.pl

Dział exportu:

tel.: +48 56 619 81 15

tel.: +48 56 619 81 53

tel.: +48 56 619 82 01

tel.: +48 56 619 82 06

fax: +48 56 619 81 18

export@nomet.pl

Dystrybutor:

Polska marka 
Polski produkt



www.nomet.pl